

NOTE: NOTCH TOP OF PARTITION TO ACCOMMODATE CEILING SUPPORTS.

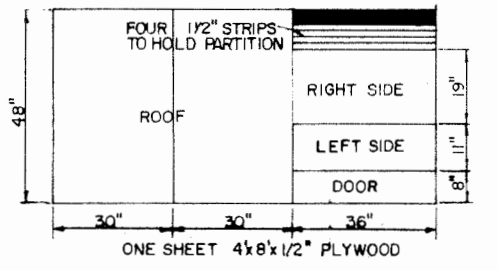
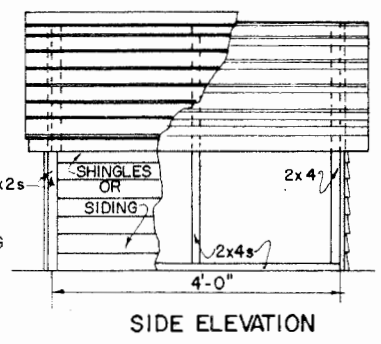
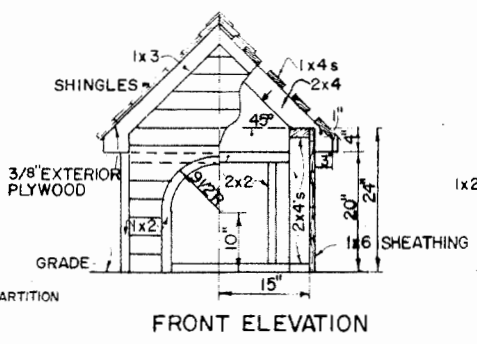
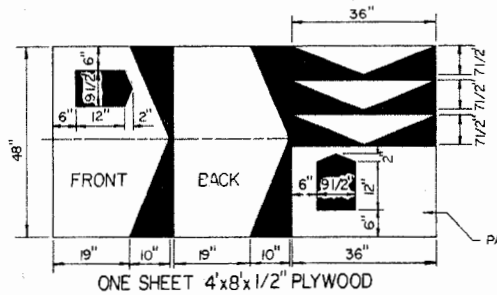
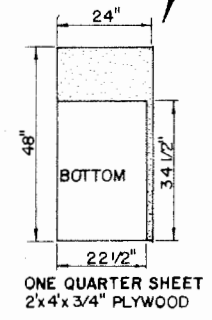
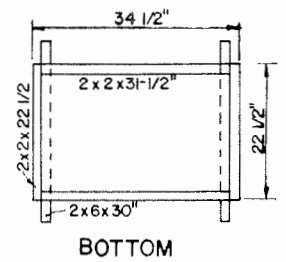
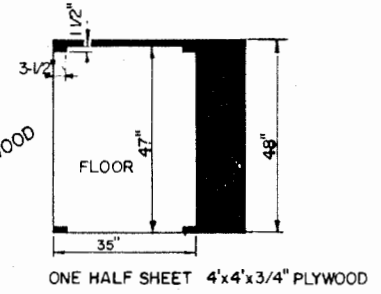
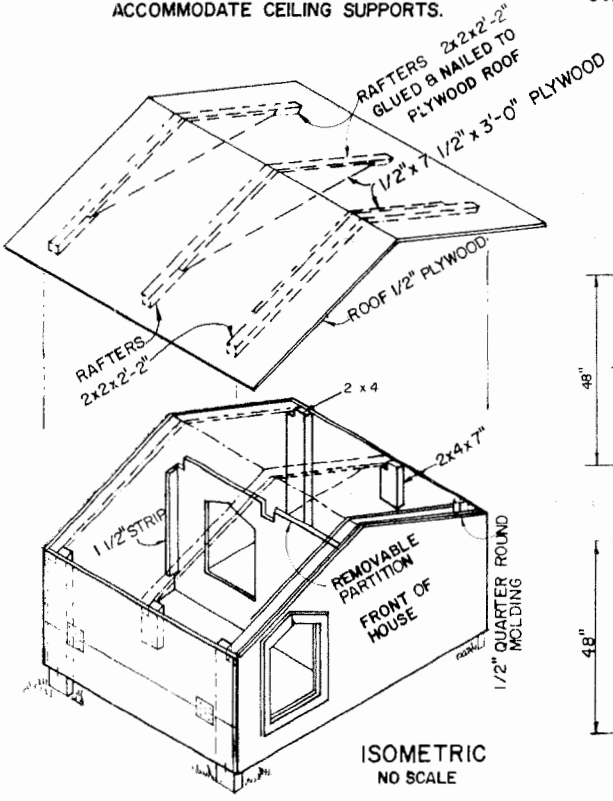

SCALE: 3/4" = 1'-0" UNLESS OTHERWISE NOTED

LSU
AgCenter
Research & Extension

DOG HOUSES
TYPES A, B, & C

USDA '77	6278	SHEET 1 OF 1
REV '87		

Disclaimer

This site makes available conceptual plans that can be helpful in developing building layouts and selecting equipment for various agricultural applications. These plans do not necessarily represent the most current technology or construction codes. They are not construction plans and do not replace the need for competent design assistance in developing safe, legal and well-functioning agricultural building system. The LSU Agriculture Center, the Mid-West Plan Service, the United States Department of Agriculture and none of the cooperating land-grant universities warranty these plans.