

CROSS SECTION OF HIVE BODY AND FRAME:

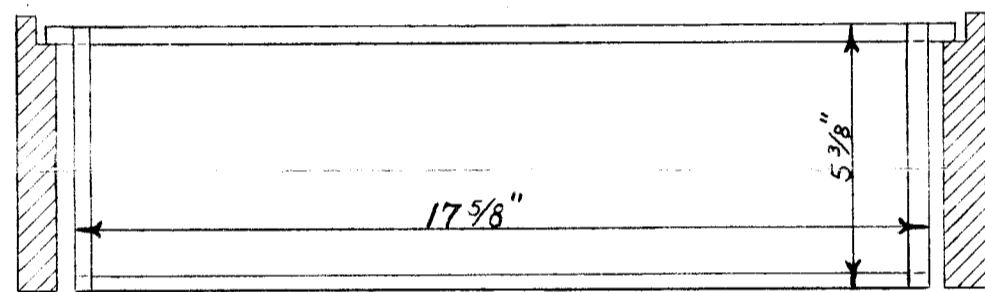

CROSS SECTION OF SHALLOW SUPER:

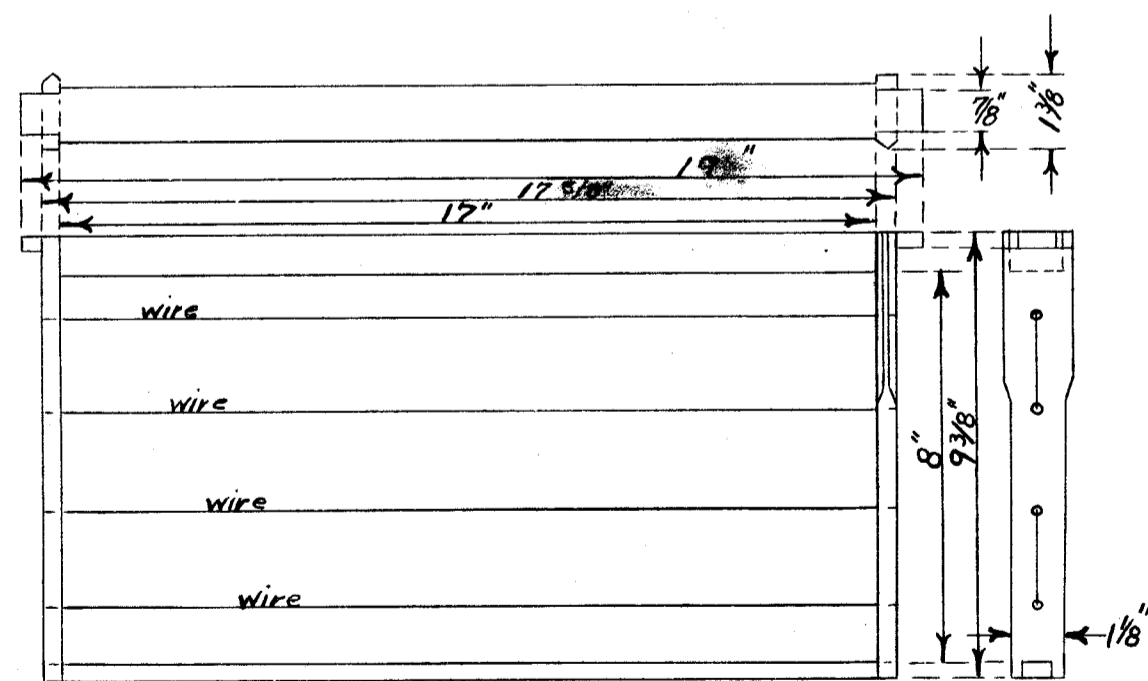

TOP, SIDE, AND END ELEVATION OF FRAME:

SCALE: 1/4" = 1"

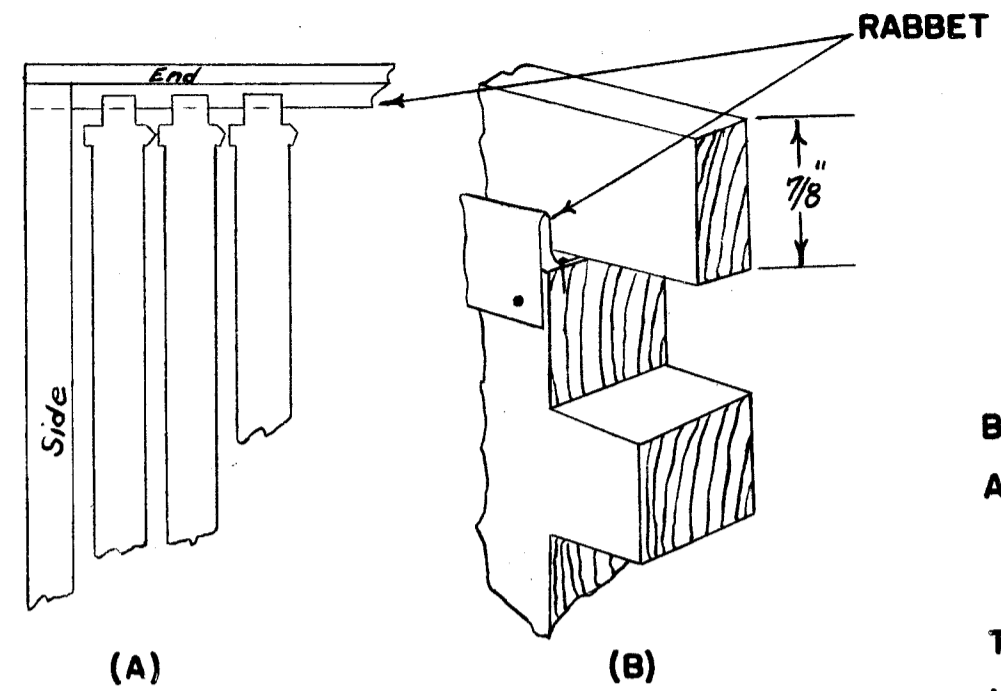

(A) CORNER OF 10-FRAME HIVE BODY, SHOWING CONSTRUCTION; ALSO POSITION OF THE FRAMES.

(B) PORTION OF THE END OF THE HIVE BODY SHOWING RABBET WHICH SHOULD BE MADE OF TIN OR GALVANIZED IRON.

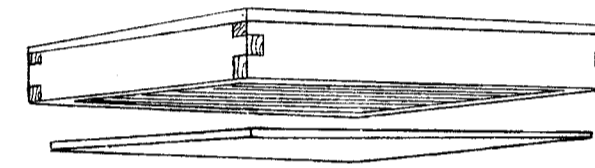

OUTER COVER
INNER COVER

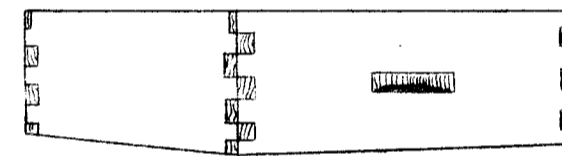

SHALLOW SUPER



QUEEN EXCLUDER

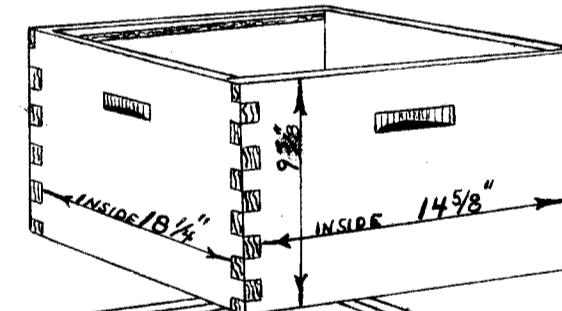

BROOD CHAMBER

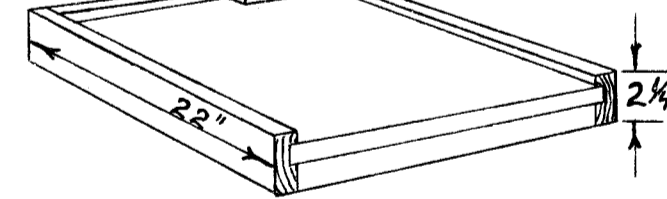

BOTTOM BOARD

COOPERATIVE EXTENSION WORK
IN AGRICULTURE AND HOME ECONOMICS
LOUISIANA STATE UNIVERSITY & A. & M.
COLLEGE & U.S.D.A. COOPERATING

BEE HIVE 36-2

| | | |
|--------------------|-----------------|-----------------|
| DRAWN BY: | SHEET 1 OF 1 | No. [REDACTED] |
| TRACED BY: A.E.H. | FEB., 1943 | APPROVED BY: |
| CHECKED BY: C.J.H. | | |