

2'-0" x 10'-0" FIBERGLASS WINDOW (CLEAR)

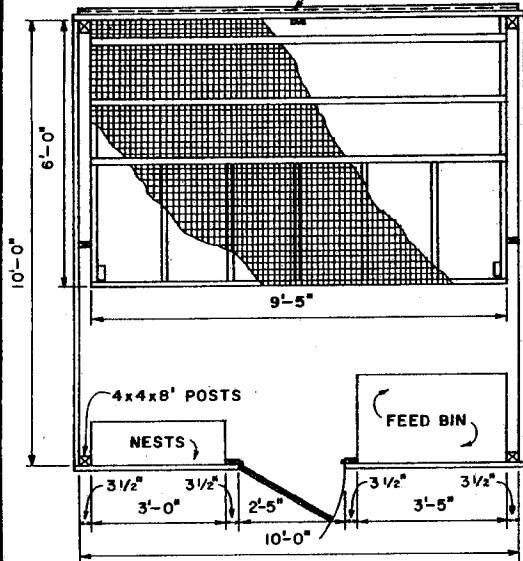

PLAN
SCALE: 1/2" = 1'-0"

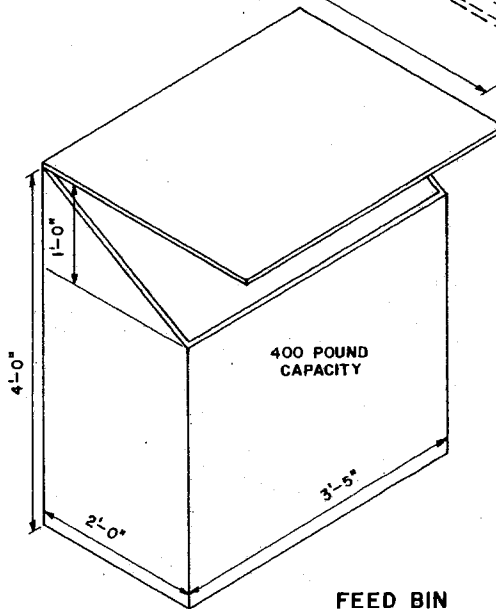
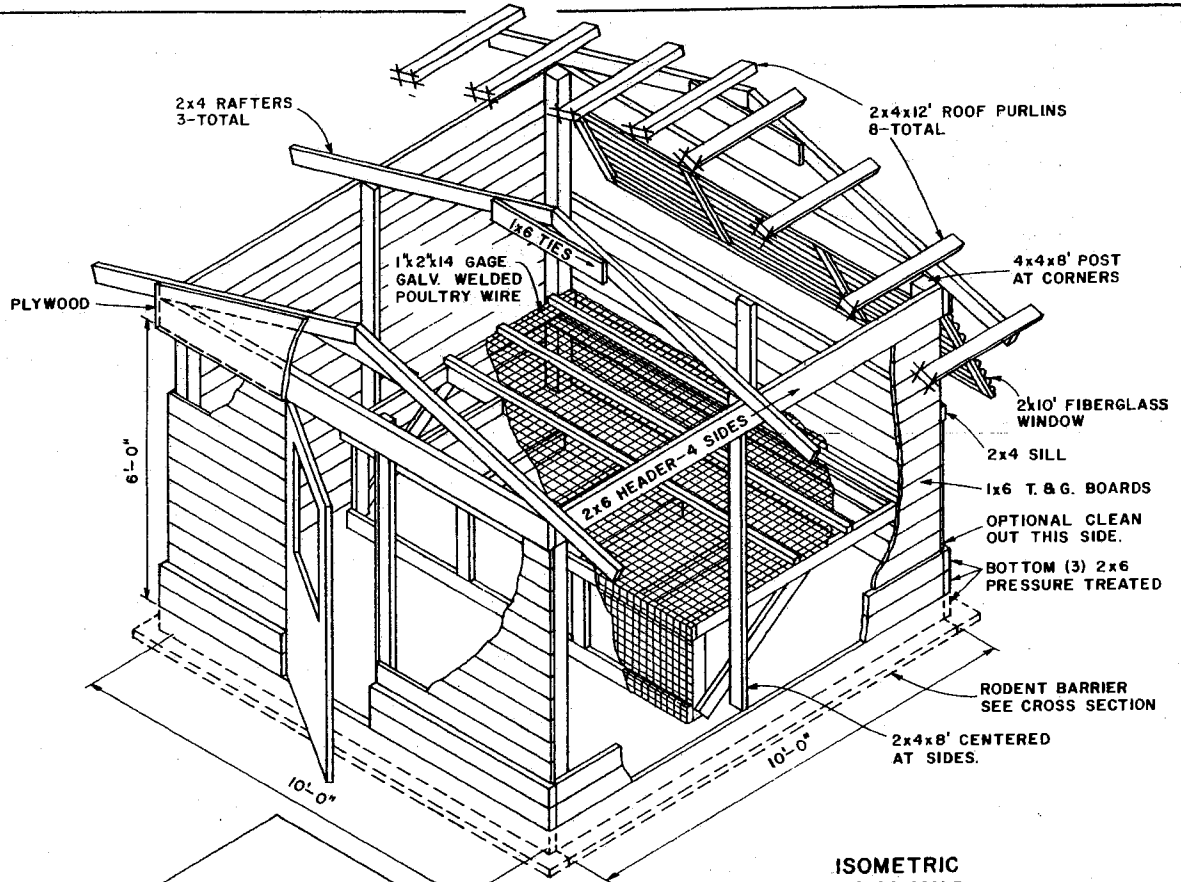

FEED BIN

BASED ON: RUTGERS-THE STATE
UNIV. OF N.J. PLAN NO. 157

12" 6" 0" 1"
SCALE: 1" = 1'-0" UNLESS OTHERWISE NOTED



POULTRY HOUSE
40-50 BIRDS

N.J. '75 6195 SHEET 1 OF 2

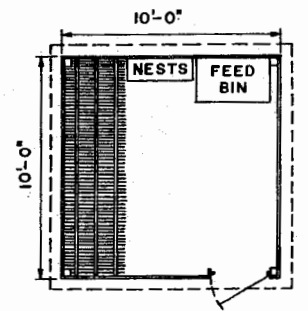
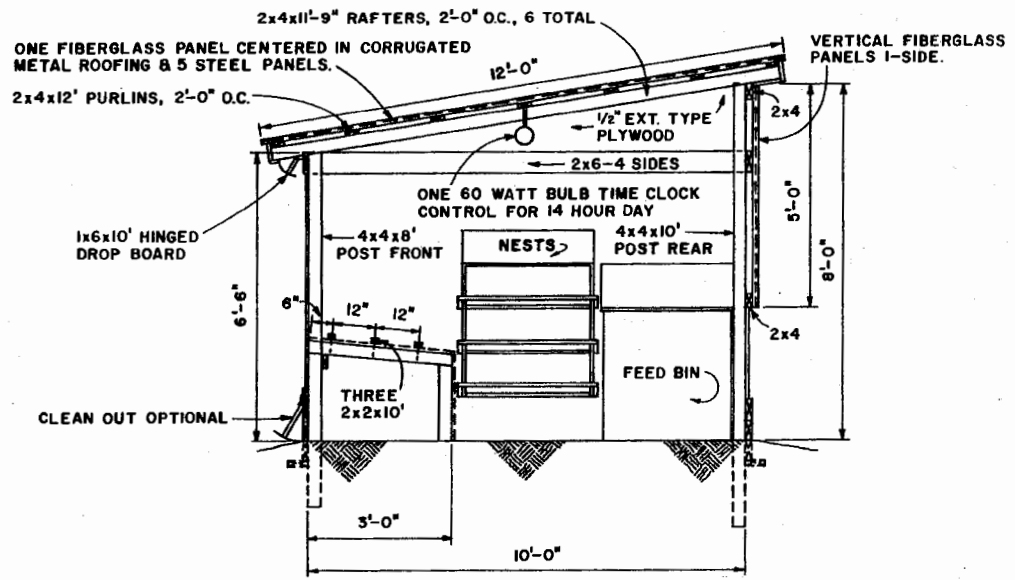
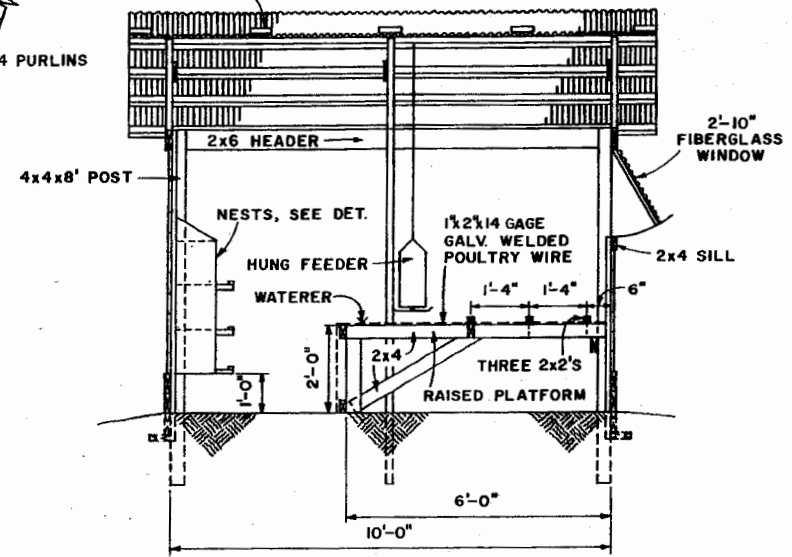
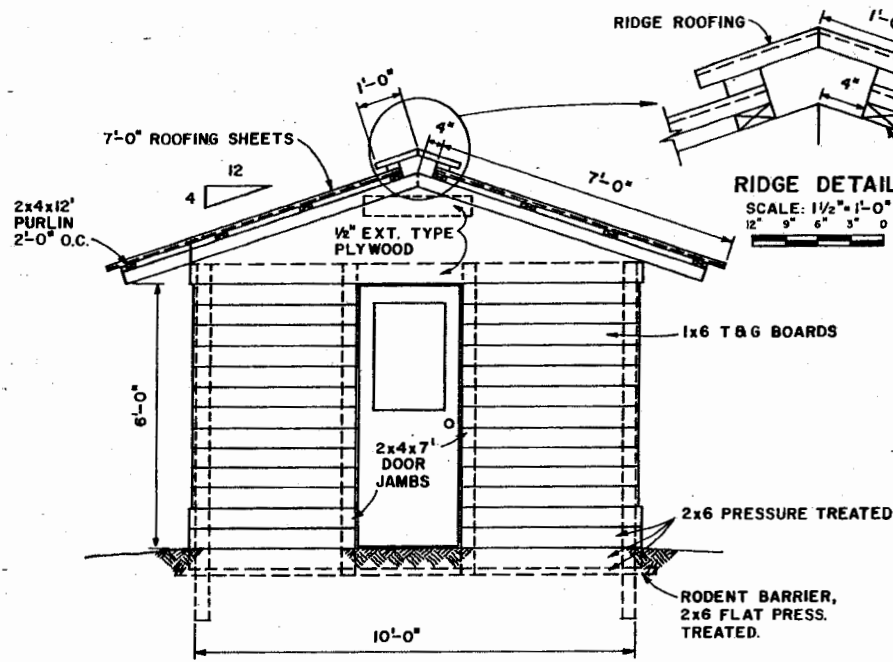

SCALE: 1/2"=1'-0" UNLESS OTHERWISE NOTED.

LSU
Ag Center
Practice & Extension

POULTRY HOUSE
40-50 BIRDS

N.J.	'75	6195	SHEET 2 OF 2
------	-----	------	--------------

Disclaimer

This site makes available conceptual plans that can be helpful in developing building layouts and selecting equipment for various agricultural applications. These plans do not necessarily represent the most current technology or construction codes. They are not construction plans and do not replace the need for competent design assistance in developing safe, legal and well-functioning agricultural building system. The LSU Agriculture Center, the Mid-West Plan Service, the United States Department of Agriculture and none of the cooperating land-grant universities warranty these plans.