

**CONSTRUCTION STEPS**

1. STUDY PLANS AND DETAILS THOROUGHLY.
2. OUTLINE SPACE FOR REFRIGERATOR ON LEVEL CONCRETE FLOOR.
3. CONSTRUCT EXTERIOR WALLS AND FIT BY FASTENING IN PLACE TEMPORARILY.
4. FASTEN ANY TWO ADJACENT WALLS PERMANENTLY; REMOVE OTHER TWO.
5. CONSTRUCT ROOF, NAIL ON VAPOR-BARRIER PAPER ALLOWING 10" OVERHANG.
6. SET ROOF IN PLACE, FOLDING PAPER AROUND EDGES INTO ROOM.
7. PLACE AND FASTEN OTHER WALLS IN POSITION.
8. APPLY ASPHALT PAINT AND ONE LAYER OF VAPOR-BARRIER PAPER—ONE WALL AT A TIME. LAP PAPER 6" AT JOINTS USING SEAM FILLER UNDER OVERLAP, SEE DETAIL, SHEET 2.
9. APPLY SECOND LAYER OF VAPOR-BARRIER PAPER, STAGGER SEAMS.
10. APPLY ASPHALT PAINT AND PAPER TO FLOOR AS IN STEPS 8 & 9.
11. LAY INSULATION ON FLOOR.
12. COVER INSULATION WITH WATERPROOF PAPER OR ROOFING FELT.
13. BUILD CONCRETE FORMS FOR REFRIGERATOR FLOOR.
14. POUR CONCRETE AND SET ANCHOR BOLTS FOR INTERIOR WALL PLATE.
15. BUILD INTERIOR FRAMING — AFTER CONCRETE IS THOROUGHLY SET.
16. INSTALL ELECTRICAL AND REFRIGERANT TUBING DUCTS.
17. INSULATE WALLS AND CEILING.
18. INSTALL INSIDE WALLS AND CEILING.
19. CALK, PLUMB, AND BOLT DOOR FRAMES IN PLACE.
20. HANG DOORS AND ADJUST LATCHES SO GASKETS WILL EXERT PRESSURE ALL AROUND.
21. HAVE REFRIGERATION EQUIPMENT AND WIRING INSTALLED.
22. INSTALL SHELVES, MEAT RAIL, AND OTHER ACCESSORIES.
23. PAINT ALL WOODEN SURFACES WITH ALUMINUM PAINT. LEAVE DOORS OPEN UNTIL SURFACES ARE DRY.



**LSU**  
AgCenter  
LAND GRANT UNIVERSITY

**TWO-TEMPERATURE WALK-IN REFRIGERATOR FOR THE FARM**

ENGINEER	SCALE
DRAWN BY	SHEET 1 OF 4
TRACED BY VR	DATE
	NO. 36-1

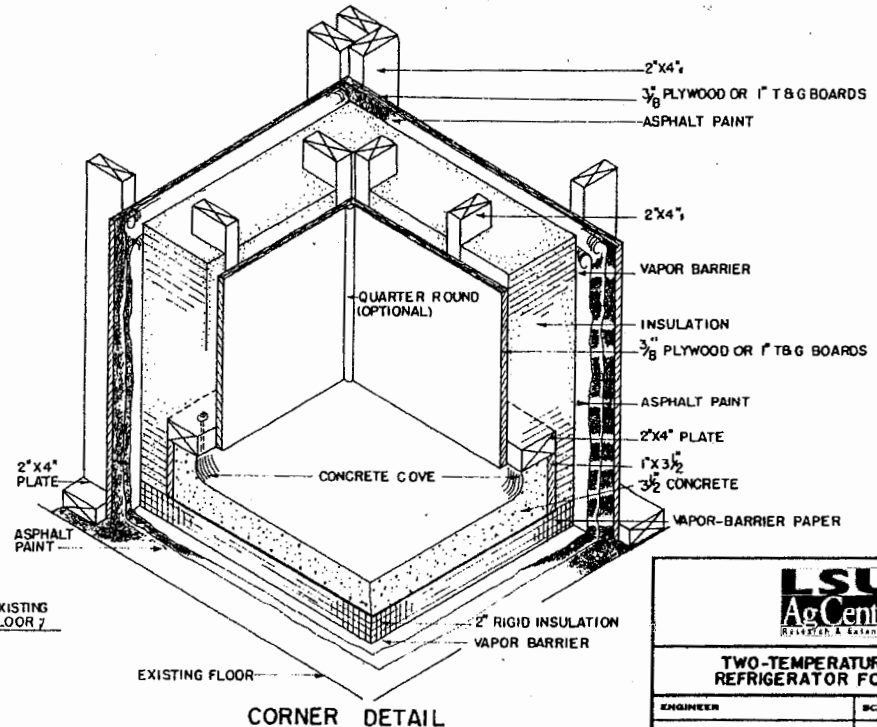
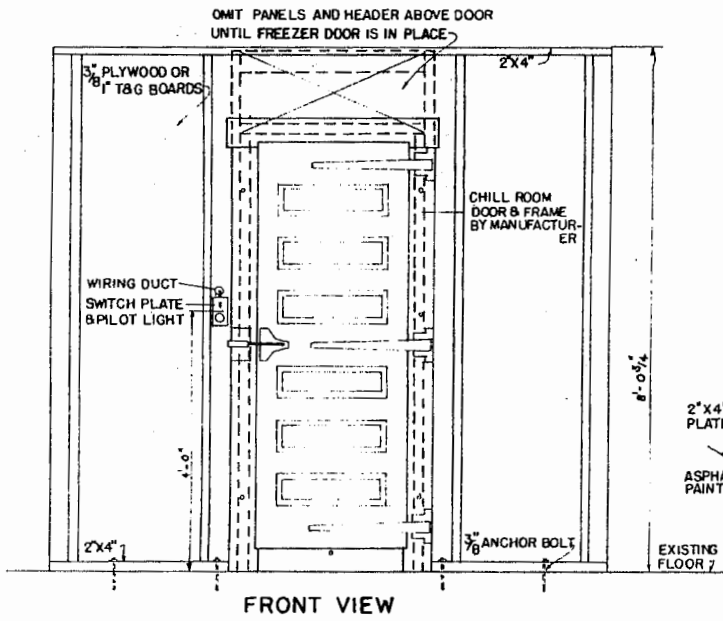
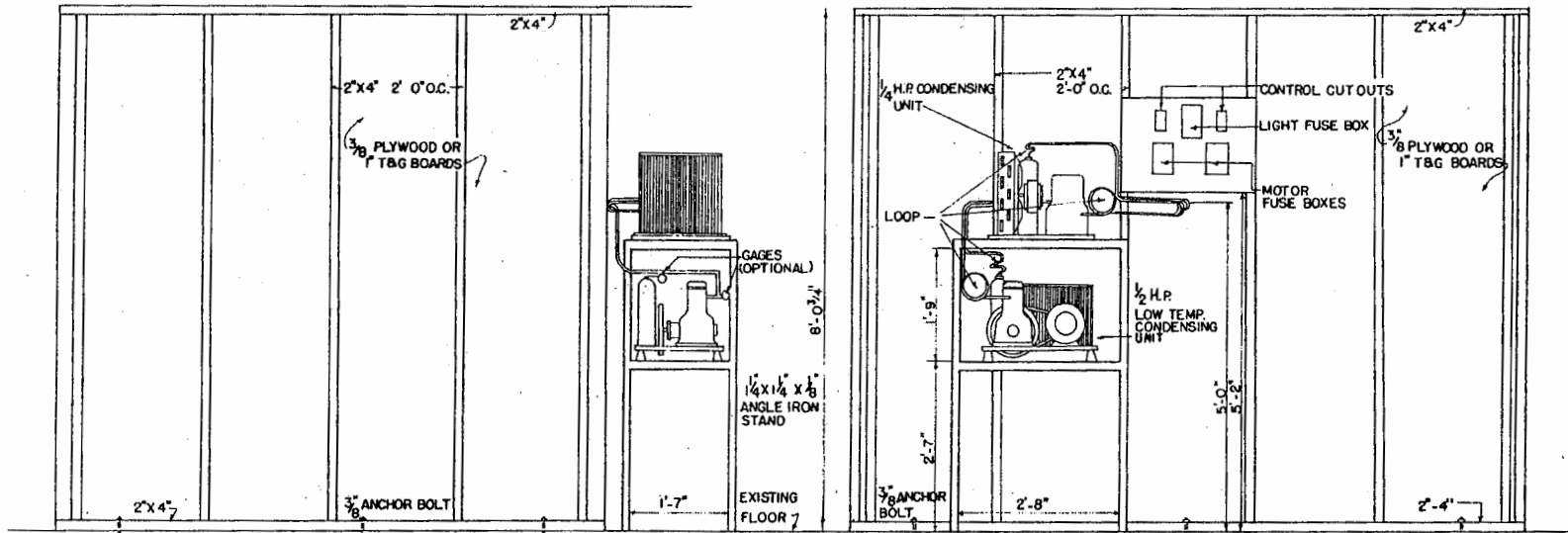

**TWO-TEMPERATURE WALK-IN REFRIGERATOR FOR THE FARM**

ENGINEER	SCALE
DRAWN BY	SHEET 2 OF 4
TRACED BY	DATE
	NO. 36-1

Division No. 1948 (Revised)

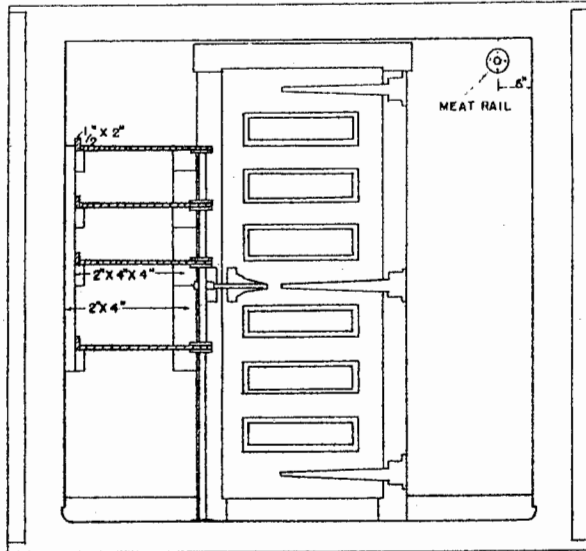

SECTION C-C

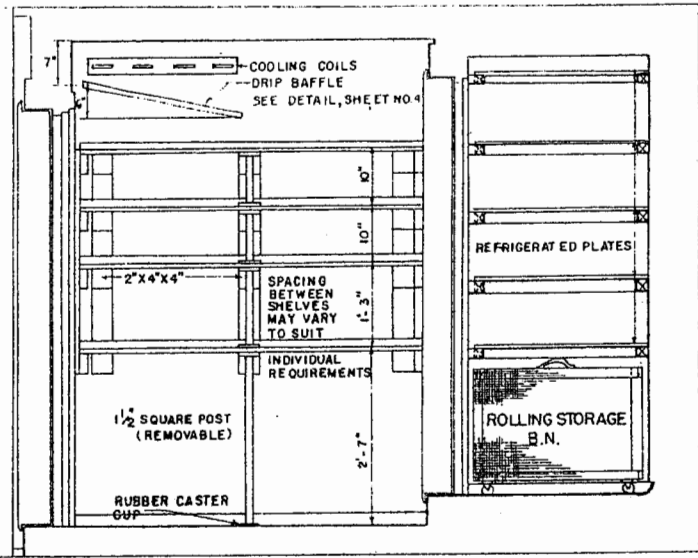

SECTION A-A

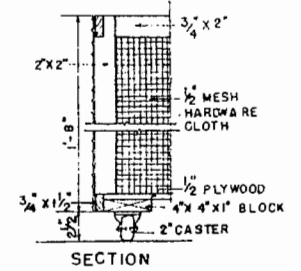

SECTION

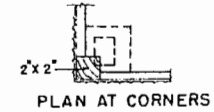

PLAN AT CORNERS

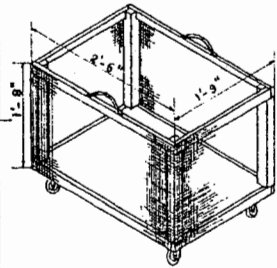

DETAILS OF ROLLING STORAGE BIN

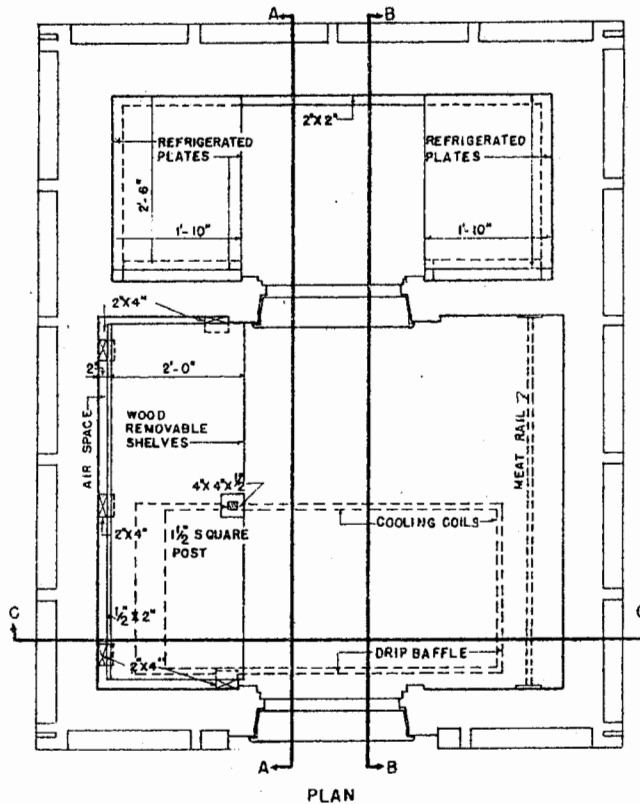

PLAN

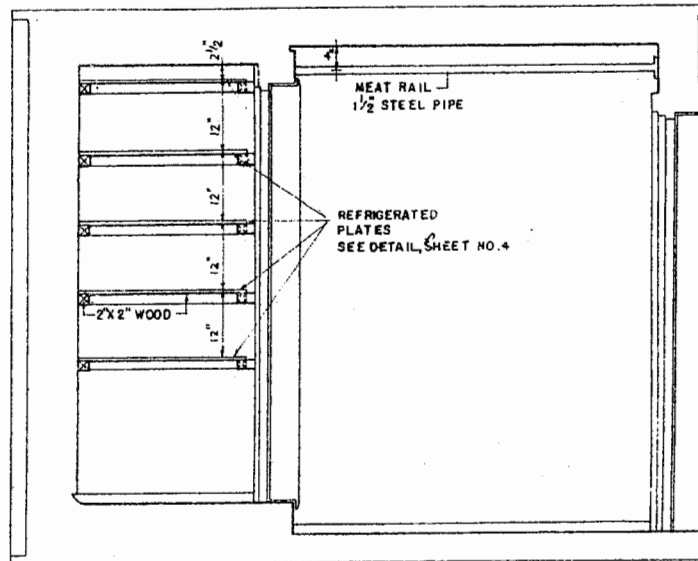

SECTION B-B

PLAN AND SECTIONS SHOWING SHELVING AND OTHER INTERIOR DETAILS



TWO-TEMPERATURE WALK-IN REFRIGERATOR FOR THE FARM

ENGINEER	SCALE
DRAWN BY	SHEET 3 OF 4
TRACED BY	DATE
	NO. 36-1

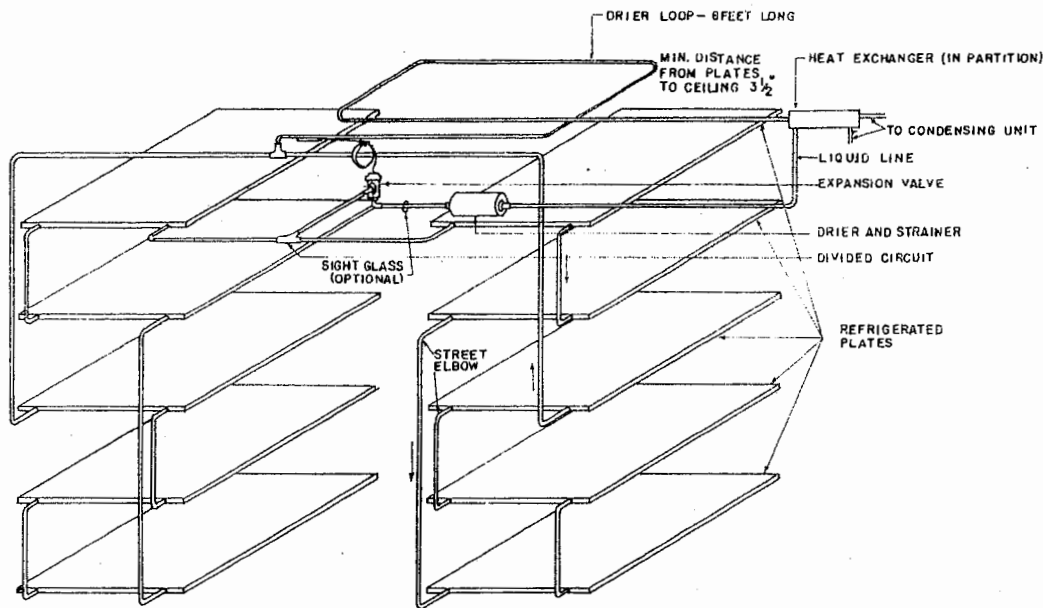

DETAIL OF REFRIGERATED PLATES IN FREEZER

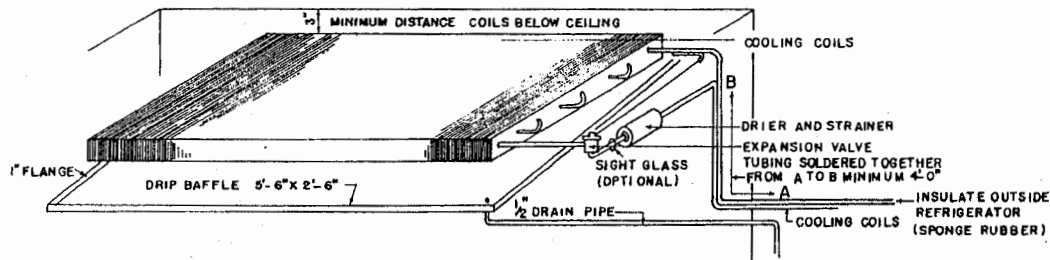

DETAIL OF COOLING COILS IN CHILL ROOM

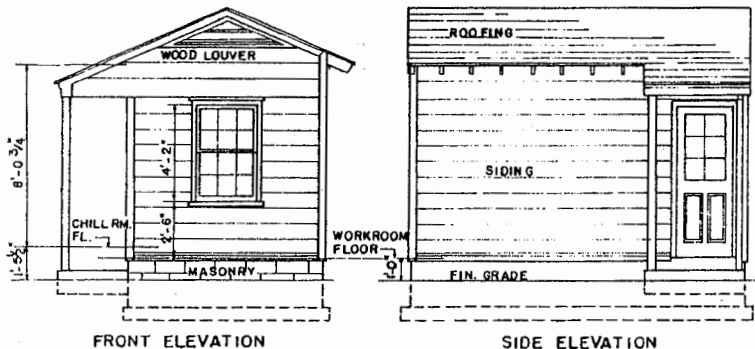

FRONT ELEVATION

SIDE ELEVATION

SCHEME "A"

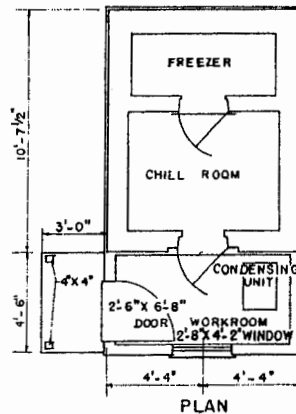

NOTE:  
IF SUITABLE SPACE IS NOT AVAILABLE IN EXISTING BUILDINGS OR IF IT IS DESIRED TO BUILD THE REFRIGERATOR AS A SEPARATE STRUCTURE, SCHEMES "A" & "B" ARE TWO OF MANY THAT MAY BE USED. THE TYPICAL WALL SECTION SHOWS THE MINIMUM STRUCTURAL REQUIREMENTS FOR A SATISFACTORY INSTALLATION.

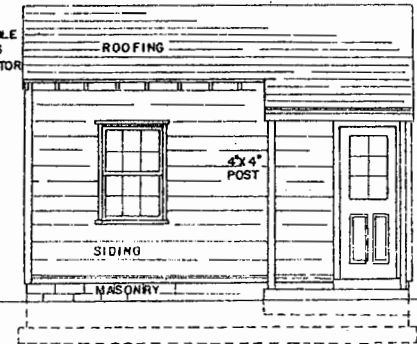

SIDE ELEVATION

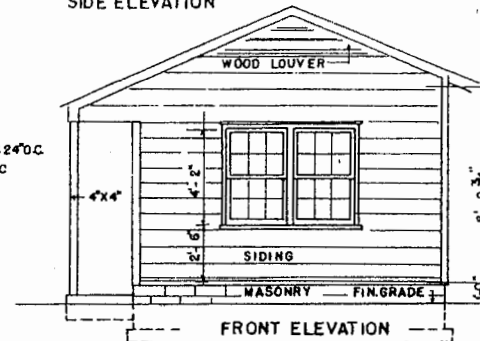

FRONT ELEVATION

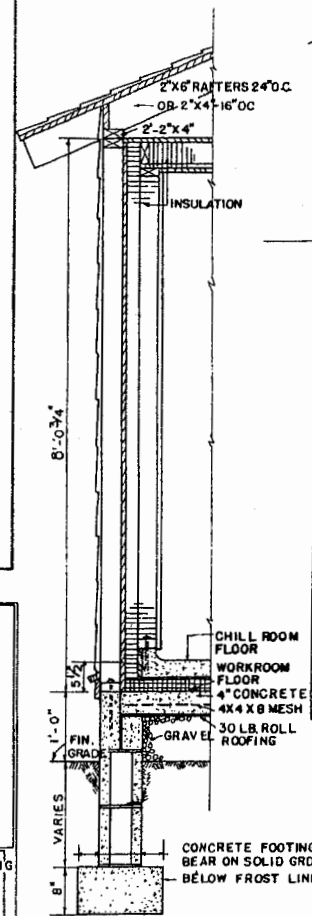

WALL SECTION A-A

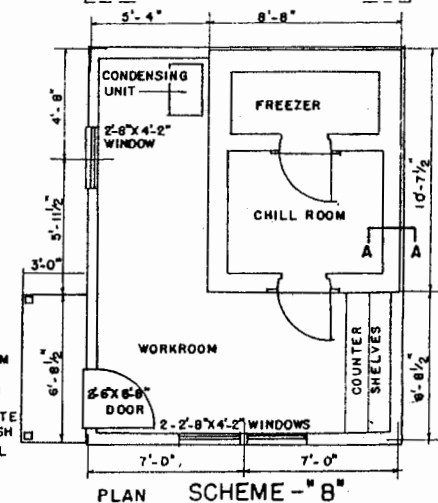

**LSU**  
**AgCenter**  
RESEARCH & EXTENSION

**TWO TEMPERATURE WALK-IN REFRIGERATOR FOR THE FARM**

ENGINEER	SCALE
DRAWN BY	SHEET 4 OF 4
TRACED BY	DATE NO. 36-1

## Disclaimer

This site makes available conceptual plans that can be helpful in developing building layouts and selecting equipment for various agricultural applications. These plans do not necessarily represent the most current technology or construction codes. They are not construction plans and do not replace the need for competent design assistance in developing safe, legal and well-functioning agricultural building system. The LSU Agriculture Center, the Mid-West Plan Service, the United States Department of Agriculture and none of the cooperating land-grant universities warranty these plans.